

Apartment

Luca Residence

IJzerstraat 7 / 02.01

8620 Nieuwpoort

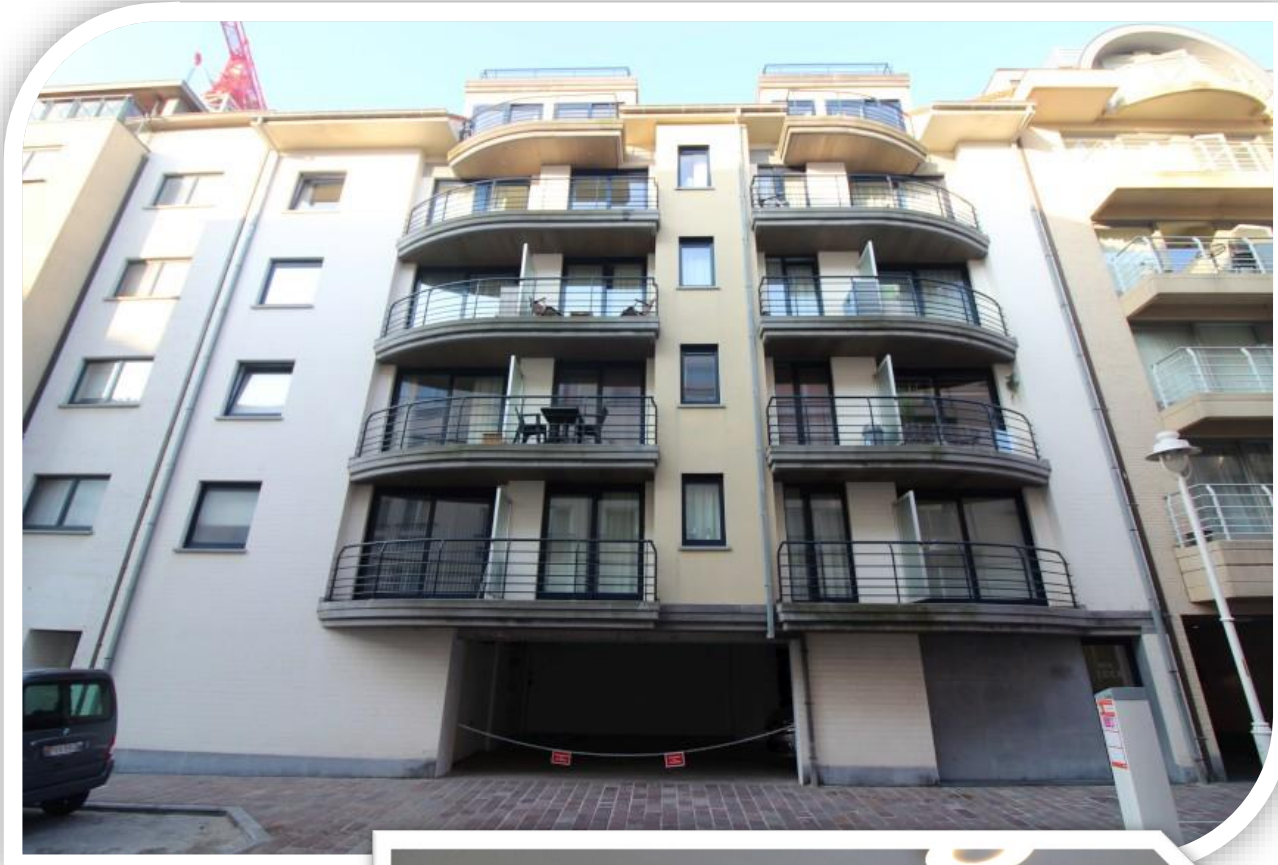

Contact:

Wesley Gybels

+32 475 / 705 106

wesley_gybels@hotmail.com

Dear guest

Enjoy your stay !

In this brochure you can read some important instructions regarding the apartment and the use of the appliances.

I wish you a lot of fun in Nieuwpoort!

Regards

Wesley

What do you need to provide yourself?

- ✓ Kitchen: Towels and dish cloths are **not present**.
- ✓ Bathroom: Towels are **not present**.
- ✓ If you like, coffee pods (type Dolce Gusto) (not always in the store).
- ✓ All bed linen is **present**.

Access to the garage and the apartment

The garage is **not included** in the rental of the apartment ! Contact me if interested.

In the garage opening at the bottom of the building, you can find four key boxes:



APARTMENT

The key box with number 1 contains the key of the apartment. With this key you can access both the entrance door of the building and the entrance door of the apartment.

The apartment is located on the second floor, on the left side when you get off the elevator.

- Do not lose the key ! -

If you lose the key, you will no longer be able to enter the apartment.

You can always leave the key in the key box when leaving the apartment to avoid loss (on the beach etc.)

No one can get there with a spare key in the short term !

Lights

The operation of the light in the living room and the bedrooms is done with the white remotes:



The lightswitches on the wall should always be on otherwise the remotes won't work.

When you press the top button ' | ' several times, the color of the lights changes.

You can set the desired atmosphere.

You can put the remote control back into the magnetic holder.

Tea lights



The tea lights can be charged in the base station and can be operated with the remote control.

You should keep the remote control close to the tea lights to set the desired atmosphere.

Please do not use real tea lights or candles. (Fire hazard)

WiFi

WiFi network: telenet-0612639
WiFi password: z6bvms5xjnNn

Using Digital TV and Netflix

2 REMOTE CONTROLS

DIGICORDER TV



How to watch digital TV?

You need the two remote controls: TV + Digicorder

Setting Remote Control Philips Smart TV:



Press the ON key



Source = Select ' Telenet Digicorder '

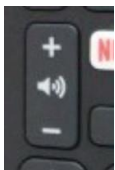

Turn volume to 15

Setting remote Control Telenet Digicorder:

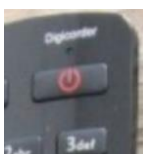

Press the ON key

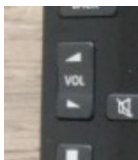

Adjust the volume
(no longer on TV remote control)



Menu

Now you only need this remote control.

Telenet Digital TV

Telenet Play = Free movies

Zendernummering Telenet digitale tv in Vlaanderen Numérotation des chaînes de la tv digitale de Telenet en Flandre



BASISAANBOD/OFFRE DE BASE

TV-ZENDERS/CHAÎNES DE TÉLÉVISION

001 vtm	
002 één	HD
003 VIJF	HD
004 Canvas	HD
005 2BE	HD
006 VIJF	HD
007 Vitaya	HD
008ATV (Antwerpen)	
008AVS (Eeklo)	HD
008AVS (Gent)	HD
008AVS (Oudenaarde)	HD
008Focus (West-V)	HD
008TV Oost (Dendermonde)	
008TV Oost (Sint-Niklaas)	
008Ring-TV (Brusselse rand)	
008ROB (Vlaams-Brabant)	
008RTV (Geel)	
008RTV (Herenthout)	
008RTV (Mechelen)	
008RTV (Turnhout)	
008BRUZZ (Brussel)	
008no télé (Komen)	
008WTV (West-Vlaanderen)	HD
008TV Limburg (Limburg)	
009Acht	
010 Kanaal Z	HD
011 Play time-kanaal	HD
012 Ketnet	HD
013 FOX	HD
015 Discovery Vl.	HD
016 Nat. Geographic	HD
017 TLC	HD
018 Comedy Central	
019 MTV	
020 Njam!	
021 Viceland	HD
022 Plattelands TV	HD
025 Sundance TV	HD
026 BBC Entertainment	
029 Disney Channel Vl.	HD
030 KADET	
031 Nickelodeon/Spike	HD
032 Nick Jr	
033 Studio 100 TV	HD
034 vtmKzoom	
037 MENT TV	
038 Disney Junior	
039 Q-music	
040 Stories	
042 Actua TV	
043 Cartoon Network	
044 Xite	
045 Dobbitt TV	
050 Brava	
051 Evenaar	
062 BBC One	
100 NPO 1	
101 NPO 2	
102 NPO 3	
120 BBC One	
121 BBC Two	
130 La Une	
131 La Deux	
132 RTL TVI	
133 Club RTL	
134 Plug RTL	
135 AB3	
137 Radio Contact Vision	
138 La Trois	
150 TF1	
151 France 2	
152 France 3	
153 France 4	
154 France 5	
155 ARTE Belgique	
156 TV 5 Monde	
158 France Ô	
159 Sundance TV FR	
170 ARD	
171 ZDF	
175 RTL Television	
176 VOX	
177 n-tv	
180 RAI Uno	
181 TVE Internacional	
184 TRT Turk	
185 TV Polonia*	
187 Mediaset Italia	
188 The Israëlï Network	
190 Play Sports infokanaal	
191 2M Maroc	
192 Al Maghreb TV	
210 Eurosport 1	HD
211 Eurosport 2	HD
401 CNN	
402 CNBC Europe	
403 BBC World News	
404 Al Jazeera English	
405 Euronews	
407 Bloomberg	
410 Russia Today	
411 CGTN	

RADIOZENDERS/CHAÎNES DE RADIO

444 Telenet demokanaal	
881 NPO 3FM	
882 NPO Radio 1	
883 NPO Radio 2	
884 NPO Radio 4	
886 France Culture	
887 France Inter	
888 France Musique	
890 BBC Radio 1	
891 BBC Radio 2	
892 BBC Radio 3	
893 BBC World Service	
895 WDR 2	
896 WDR 3	
897 WDR 4	
898 WDR 5	
899 1LIVE	
900 Radio 1	
901 Radio 2 Vlaams Brabant	
902 MNM	
903 Studio Brussel	
904 Klara	
905 Klara Continuo	
906 MNM Hits	
907 VRT NWS	
909 Sporza	
910 Q-music radio	
911 JOE fm	
912 Radio Maria	
913 TOPradio	
914 Radio 2 Antwerpen	
915 Radio 2 Limburg	
916 Radio 2 Oost Vlaanderen	
917 Radio 2 West Vlaanderen	
918 Radio Nostalgie	
919 ClubFM	
920 La Première	
921 VivaCité	
922 Musiq3	
923 Pure FM	
924 Classic21	
926 Bel RTL	
927 Radio Contact	
928 Mint	
929 Radio France Internationale	
930 Family Radio	

935 BRF1	
936 Radio Judaïca	
941 Hit FM	
942 Zen	

STINGRAY MUSIC

990 Total Hits - UK	
991 Rock Alternative	
992 Dance Floor Fillers	
993 70's	
994 Chillout	
995 Reggae Vibra	
996 Headbangers	
997 Rock Anthems	
998 Freedom	
999 Jazz Classics	

PLAY SPORTS

199 Play Sports Info	
200 Play Sports 1	HD
201 Play Sports 2	HD
202 Play Sports 3	HD
203 Play Sports 4	HD
204 Play Sports 5	HD
205 Play Sports 6	HD
206 Play Sports 7	HD
207 Play Sports 8	HD
208 Play Sports Golf	HD
212 Eleven Sports 1	HD
213 Eleven Sports 2	HD
366 Extreme Sports	

PLAY

DOCU

350 Discovery World	
351 Investigation Discovery	
352 Discovery Science	
353 History	
354 Animal Planet	HD
355 Nat Geo Wild	HD

LIFESTYLE

360 OUTtv	
361 Food Network	
362 Travel Channel	
363 E! Entertainment	HD

KIDS

370 Disney XD	
371 Boomerang	
372 Nick Toons	
373 Jim Jam	
374 Baby TV	

Zendernummering Telenet digitale tv in Vlaanderen

Numérotation des chaînes de la tv digitale de Telenet en Flandre



380 Nick Hits	
MUSIC	
381 VH1	
382 MTV Rocks	
383 MTV Live	HD
384 Mezzo	
950 Classical Greats	
951 Classical Calm	
952 Classical Orchestral	
953 Belpop	
954 Chansons	
955 Silk	
956 Ultimate Urban	
957 Bass, Breaks & Beats	
958 Groove (Disco & Funk)	
959 Drive	
960 All Day Party	
961 World Carnival	
962 Indie Classics	
963 Rock 'n' Roll	
964 Classic Rock	
965 Strictly 60's	
966 80's	
967 90's	
968 R'n'B & Soul	
969 Hip Hop	
970 Cool Jazz	
971 Blues	
972 Hot Country	
973 Cocktail Lounge	
974 Revival	
975 Schlager	
976 Türk Müziği	
977 Total Hits France	
978 Total Hits Italy	
979 Total Hits Nordic	
980 Total Hits Spain	
981 Total Hits Germany	
SPORT	
366 Extreme Sports	
PLAY MORE	
FILM & ENTERTAINMENT	
300 PRIME STAR	HD

302 PRIME ACTION	HD
303 PRIME FAMILY	HD
304 PRIME FEZZIVAL	HD
305 PRIME SERIES	HD
310 BBC First	HD
311 AMC	
314 Shorts TV	HD
DOCU	
350 Discovery World	
351 Investigation Discovery	
352 Discovery Science	
353 History	
354 Animal Planet	HD
355 Nat Geo Wild	HD
LIFESTYLE	
360 OUTtv	
361 Food Network	
362 Travel Channel	
363 E! Entertainment	HD
KIDS	
370 Disney XD	
371 Boomerang	
372 Nick Toons	
373 Jim Jam	
374 Baby TV	
380 Nick Hits	
MUSIC	
381 VH1	
382 MTV Rocks	
383 MTV Live	HD
384 Mezzo	
950 Classical Greats	
951 Classical Calm	
952 Classical Orchestral	
953 Belpop	
954 Chansons	
955 Silk	
956 Ultimate Urban	
957 Bass, Breaks & Beats	
958 Groove (Disco & Funk)	
959 Drive	
960 All Day Party	
961 World Carnival	
962 Indie Classics	
963 Rock 'n' Roll	
964 Classic Rock	

965 Strictly 60's	
966 80's	
967 90's	
968 R'n'B & Soul	
969 Hip Hop	
970 Cool Jazz	
971 Blues	
972 Hot Country	
973 Cocktail Lounge	
974 Revival	
975 Schlager	
976 Türk Müziği	
977 Total Hits France	
978 Total Hits Italy	
979 Total Hits Nordic	
980 Total Hits Spain	
981 Total Hits Germany	
SPORT	
366 Extreme Sports	
ADULT	
800 Playboy TV	
801 Blue Hustler	
802 Penthouse	HD
PASSION XL	
810 X-Passion	
812 Penthouse 1	HD
813 Penthouse 2	HD
BE PREMIUM / BE SPORT	
700 Be 1	HD
701 Be Ciné	HD
702 Be Séries	HD
705 Be 1 + 1h	
BE PREMIUM / BE SPORT	
710 Be Sport 1	HD
711 Be Sport 2	
712 Be Sport 3	
725 Eleven Sports 1 FR	HD
726 Eleven Sports 2 FR	HD
OPTION VOO FOOT	
720 Voo Foot	HD
721 Voo Foot 2	
722 Voo Foot 3	
723 Voo Foot 4	
724 Voo Foot 5	

OPTION FR	
157 TV Breizh	HD
220 Eurosport.FR	
406 LCI	
510 Discovery Channel FR	
511 National Geographic FR	
610 Canal J	

Om de recentste zendernummering van Telenet digitale tv te bekomen: ga via de huisdoets naar 'Instellingen', dan 'Digicorder', en kies 'Standaardnummering herinstellen'. Het zenderaanbod is onderhevig aan wijzigingen. Voor het meest recente overzicht surf naar telenet.be/basisaanbod.
Woon je in de regio Brussel in een van de volgende postcodes: 1030, 1040, 1081, 1082, 1083, 1090, 1190, 1200, dan geldt een andere zendernummering voor jou. Je krijgt de correcte zenderkaart thuis gestuurd.

Pour obtenir la numérotation la plus récente pour les chaînes de la TV digitale: appuyez sur la touche Maison. Ensuite, allez dans "Réglages" et choisissez "Digicorder" puis "Régler la numérotation standard".
L'offre de chaînes est sujette à modification. Pour l'aperçu le plus récent, surfez sur telenet.be/offrebase.
La numérotation des chaînes est différente si vous habitez en région bruxelloise, dans l'un des codes postaux suivants: 1030, 1040, 1081, 1082, 1083, 1090, 1190, 1200.
Nous vous enverrons la liste de chaînes adaptée chez vous.

* Afhankelijk van jouw regio al dan niet beschikbaar. Deze zendernummering is van toepassing op de HD Digiboxen / HD Digicorders

Deze zenders kan je live bekijken via yeloplay.be of de Yelo Play-app.

Deze zenders kan je live bekijken via yeloplay.be of de Yelo Play-app. Van deze zenders kan je ook de opnames die je maakte met je HD Digicorder, gedurende 2 maanden bekijken via yeloplay.be of de Yelo Play-app.
Meer info over Yelo? Surf naar telenet.be/yelo.

Heb je Play of Play More? Van deze zenders kan je programma's gedurende 7 dagen herbekijken of herstarten op je tv.

* Disponible en fonction de la région. La numérotation des chaînes est valable pour les Digibox HD et Digicorder HD

Vous pouvez regarder ces chaînes en direct sur votre smartphone, tablette ou pc via yeloplay.be ou l'appli Yelo Play.

De ces chaînes, vous pouvez également regarder vos enregistrements de votre Digicorder HD, et cela pendant 2 mois après enregistrement. Plus d'infos sur Yelo? Rendez-vous sur www.telenet.be/yelo.

Avez-vous Play ou Play More? Pour ces chaînes, vous pouvez relancer ou visionner des programmes pendant 7 jours sur votre téléviseur.

How to watch Netflix and Disney ?

You need one remote control: **Digicorder**



Press 'Home' | Choose Apps | Choose Netflix or Disney

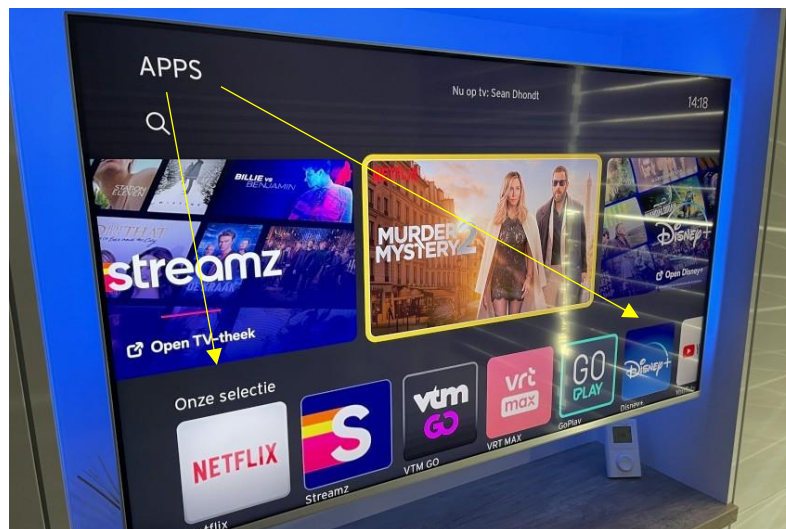

What if something goes wrong?

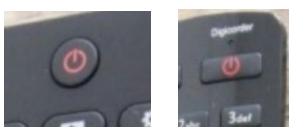

Turn off the TV and Digicorder and start from the beginning.

Please do not pull out or plug in cables into the TV or Digicorder !

Kitchen equipment

- ✓ Kitchen: Towels and dish cloths are **not present**.
- ✓ Bathroom: Towels are **not present**.
- ✓ If you like, coffee pods (type Dolce Gusto) (not always in the store).





How to use the dishwasher?

- 1 Add dishwasher pod, do not remove the plastic packaging from the pod

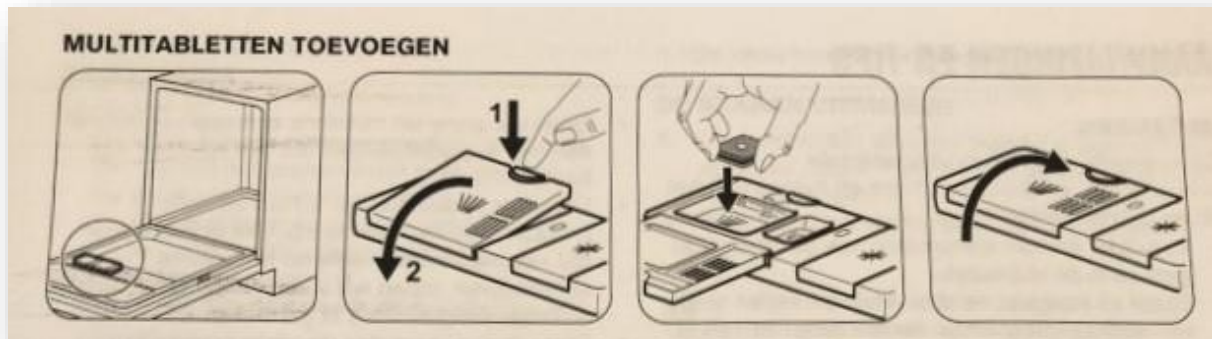

- 2 Press 'auto off'



- 3 Choose Program

(65°A30')

When the washing program is over, the door of the dishwasher opens automatically.

How to use the cooking plate?

1 on/off button

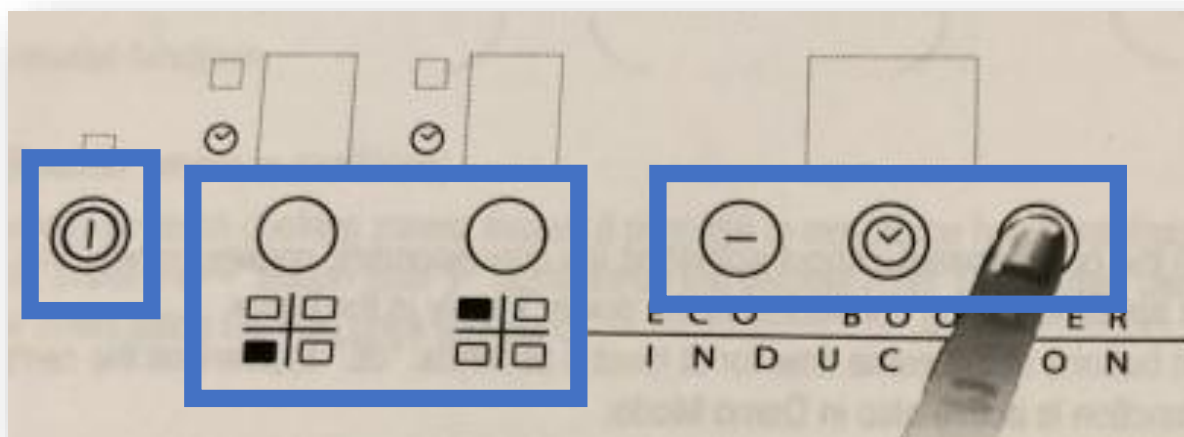

2 Choose your cooking plate

3 - / +

Use of Flexi-Cook (large cooking plate)

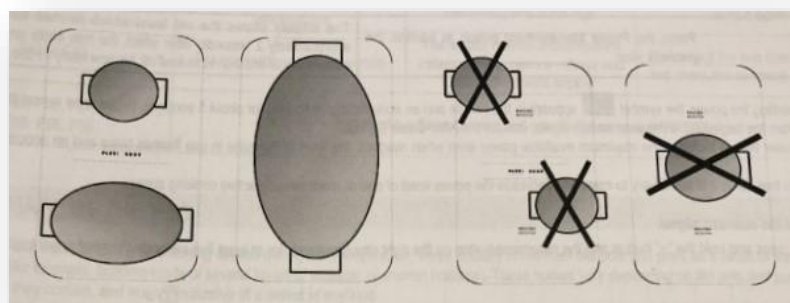

Cooking plate LOCKED?

Push on the 'E' to unlock. Do not push on the lock.

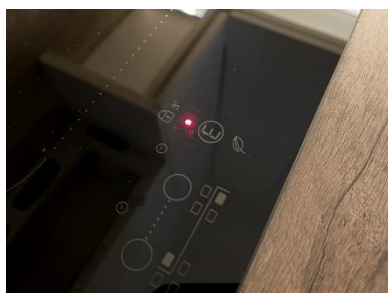

Vacuum cleaner (Dyson)

How to remove the vacuum cleaner from the holder?

- 1 Slide the vacuum cleaner along with the vacuum cleaner holder upwards.
- 2 Turn the vacuum cleaner forward and remove it from the holder.

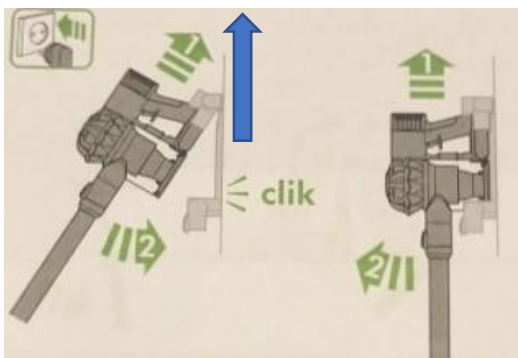

How to use the vacuum cleaner?

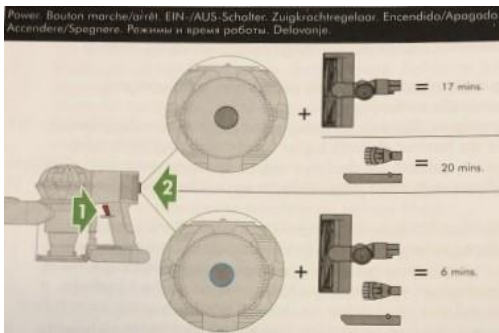

How to empty the vacuum cleaner?

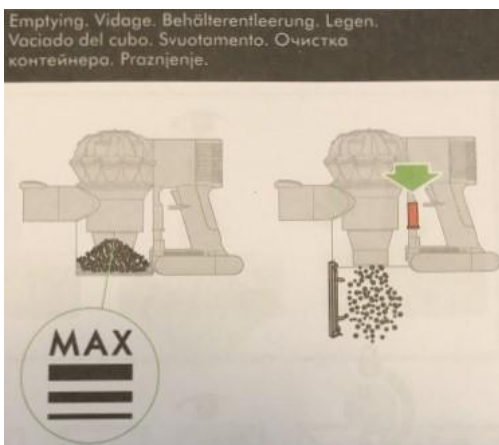

Dolce Gusto I Coffee machine



3. HOOFDFUNCTIES

3.1 GEBRUIKSVRIENDELIJKE LED-BEDIENINGSRING

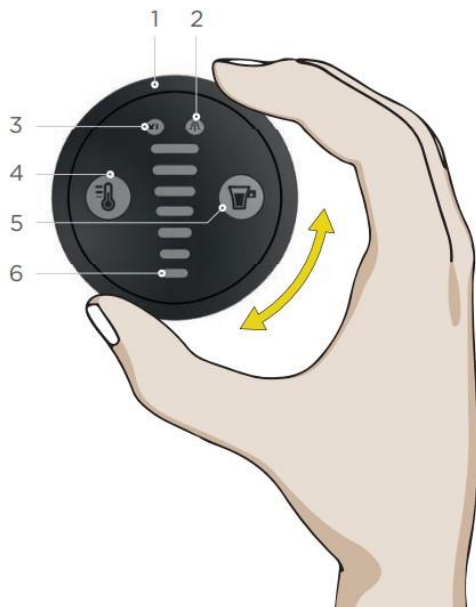

1. **Bedieningsring**
Selecteer het volume voor de drankbereiding
2. **Controlelampje voor ontkalking**
Het apparaat moet ontkalkt worden na 300 extracties
3. **XL-functie**
Bereid een extra groot kopje
4. **SELECTIE HEET EN KOUD**
Temperatuur van de drankjes kan ingesteld worden (2 vooraf gedefinieerde instellingen):



Koud



Heet



Koud, maar de watertemperatuur is nog steeds te hoog

5. **Start/stop-knop**
Start/stop drankbereiding
6. **Volumedisplay**
Geeft de voortgang van de extractie weer door vanaf het geselecteerde volume naar beneden te bewegen tot voltooiing

3.2 HET APPARAAT INSCHAKELEN

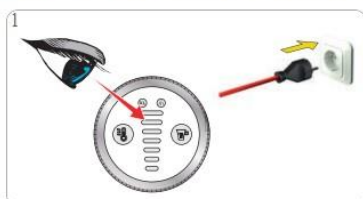

1
Zorg ervoor dat de correcte spanning gebruikt wordt die in "HET APPARAAT IN DETAIL" op pagina 6 vermeld wordt. Steek de stekker in het stopcontact.



2
Druk op een knop of draai aan de bedieningsring om het apparaat in te schakelen.



3
Het apparaat kan ook worden ingeschakeld door de vergrendelingshendel te openen.

- 1 Fill the reservoir with water.
- 2 Turn the ring / wheel.
- 3 Wait until the device has warmed up (green LED).
- 4 Use the wheel to set the amount that can be read on the coffee pad.
- 5 Add coffee pad.
- 5 Press the 'coffee button'

Oven and microwave

General & safety Instructions

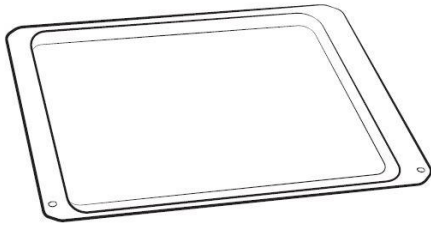

Ceramic tray
(Useful for microwave mode.)

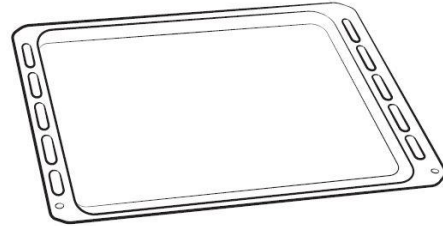

Baking trays
(Do not use for microwave mode.)

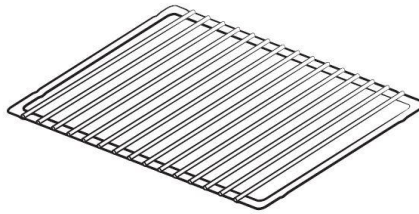

Grill insert
(Useful for speed menu and grill mode.)

Side runners

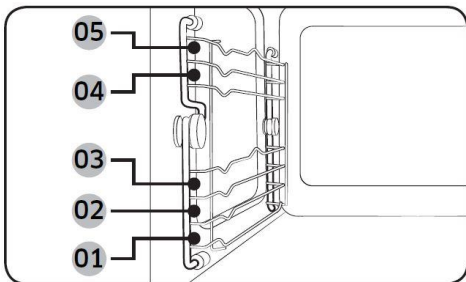

- Insert the accessory to the correct position inside of the oven.
- Take caution in removing cookware and/or accessories out of the oven. Hot meals or accessories can cause burns.

01 Level 1	Microwave function
02 Level 2	Oven function
03 Level 3	
04 Level 4	
05 Level 5	

- IMPORTANT | SAFETY -

Do not use the oven grill for the microwave! (Sparks !)

Use the right baking tray for the microwave! (Sparks !)

Settings

Operation





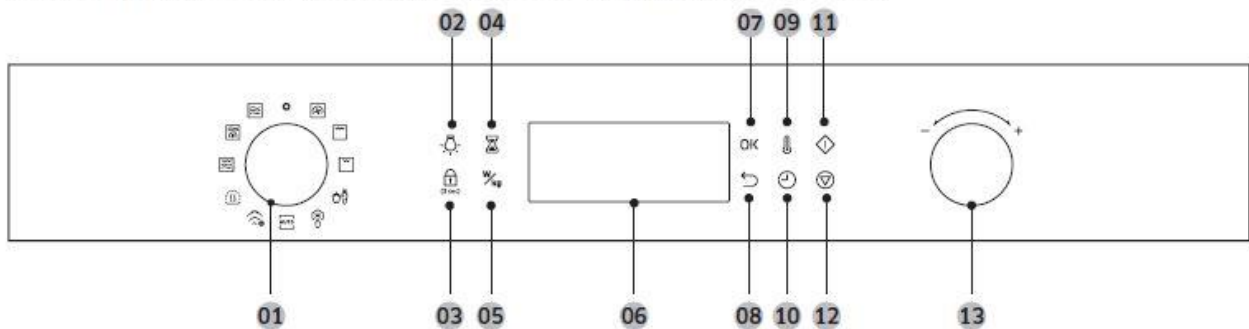

Control panel

The front panel comes in a wide range of materials and colours. For improved quality, the actual appearance of the oven is subject to change without notice.



01 Mode dial	Turn the mode dial to select a desired cooking mode or function.
02 Oven light	Press to turn the internal light on or off.
03 Child Lock	Press and hold for 3 seconds to activate or deactivate. Child Lock is available only in Standby state.
04 Timer	Timer helps you check the time or operating duration while cooking.
05 Power Level/Weight	Use to change the power level or Weight.
06 Display	Shows necessary information of selected function or settings.
07 OK	Press to confirm your settings.
08 Back	Press to return to the default setting.
09 Temperature	Use to set the temperature.
10 Cooking time	Press to set the cooking time.
11 Start	Press to start cooking.
12 Stop	Press to stop operation. This button is also used to cancel the current mode.
13 Value dial	Turn the value dial to adjust the setting value for your selection. Turn to + to increase, or turn to - to decrease.

Features

Feature		Temperature range	Default temperature	
Manual mode		Convection	40-230 °C	180 °C
			The heating elements generate heat, which is evenly distributed inside the oven by the convection fan. Use this mode for frozen food or baking.	
		Large grill	150-230 °C	220 °C
			Use this for grilling food such as meat.	
		Small grill	150-200 °C	180 °C
			The small-area grill emits heat. Use this mode for food that requires less heat, such as fish and filled baguettes.	
		Microwave	100-800 W	800 W
			The microwave energy enables food to be cooked or reheated without changing either the form or the colour.	
	Convection Combo	40-200 °C 100-600 W	180 °C 300 W	
		The heating elements generate heat and the convection fan distributes the heat inside the oven, which is reinforced by the microwave energy.		
	Grill Combo	40-200 °C 100-600 W	200 °C 300 W	
		The heating elements generate heat, which is reinforced by the microwave energy.		

Setting up the oven

Do not use the oven grill for the microwave! (Sparks !)

Use the right baking tray for the microwave! (Sparks !)

Manual mode

Step 1. Select mode

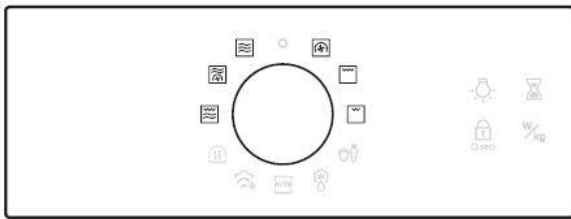

Turn the mode dial to select a manual mode, for example, **Convection**. The default temperature (or power level) blinks.

Step 2. Set temperature or Power level



Use the value dial to adjust the default temperature (or power level). When done, press **OK** to move next stage.

NOTE

If the power level or temperature is not specified within 5 seconds, the oven moves to the next stage. (Cooking time or Standby)

Step 3. Set cooking time



Press **Cooking time** to move to the time setting. (convection, Grill mode only)
Use the value dial to set the cooking time.



Optionally, you can delay the end time of your cooking to a desired point.
After set the cooking time, press .
And then use value dial to set an end point.
See **Delay End** on page 33 for more information.



When done, press .

Step 4. Preheat (Convection, Grill mode only)



The oven starts preheating until it reaches the set temperature. When complete, the oven beeps and the indicator disappears.

NOTE

When you want to change temperature or time during cooking, press the temperature button or the cooking time button, then turn the value dial to adjust value.

To change the temperature or power level during cooking



1. Press (or $\frac{W}{kg}$). The temperature (or power level) element blinks.

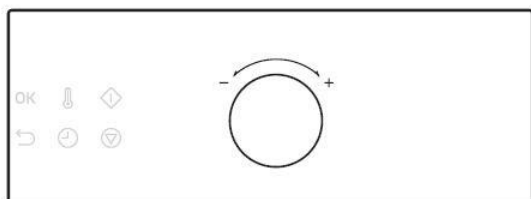

2. Use the value dial to adjust the temperature (or power level).



3. Press **OK** to confirm the changes.

To stop operation



Press once to stop operation, twice to cancel the current mode.



Or, turn the mode selector to "".

Defrost function

Defrost

The oven offers 5 defrosting programmes for your convenience. The time and power level are automatically adjusted according to the selected programme.

Step 1
Defrost

>

Step 2
1 to 5

>

Step 3
weight

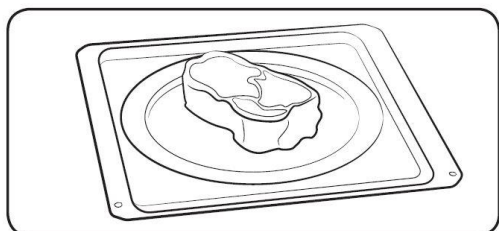

1. Put food in suitable cookware, then on the recommended accessory, and then close the door.
2. Follow steps 1-3 in the **Auto mode** on page 39.
3. When cooking is complete, "0:00" blinks. Use oven gloves to take out food.

Cleaning oven

Use only exceptionally.

Steam cleaning

This is useful for cleaning light soiling with steaming.

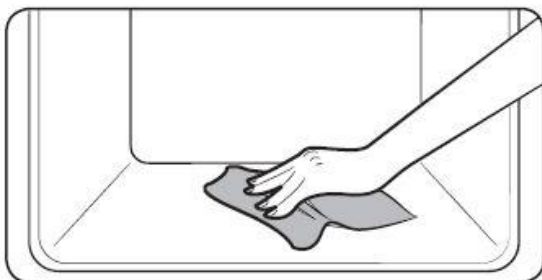
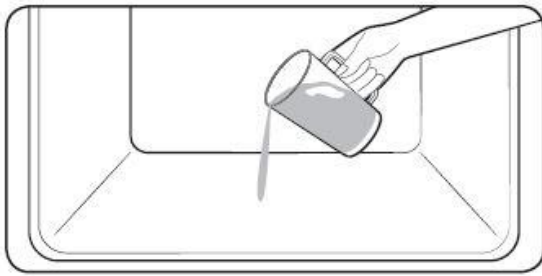

1. Pour 100 ml of water onto the bottom of the oven and close the oven door.

2. Turn the mode dial to select **Steam cleaning**.

3. Press . The oven starts cleaning.

4. Use a dry cloth to clean inside the oven.

WARNING

- Do not open the door before the cycle is complete. The water inside the oven is very hot, and it can cause a burn.

NOTE

- Use this feature only when oven has cooled completely to room temperature.
- DO NOT use distilled water.

- DO NOT use high-pressure water cleaners or steam jet cleaners to clean the microwave oven.
- While the oven is hot inside, auto cleaning is not activated. Wait until the oven cools down, and try again.
- Do not pour water onto the bottom by force. Do it gently. Otherwise, the water overflows to the front.

What to do at the end of your stay?

1 Please bring your garbage (kitchen, toilet and bathroom) to the containers (20 cents = 20 litres or 50 cents = 50 litres):

Do not forget to empty the refrigerator.

Address : Hoek Franslaan – Franz Smeersweg

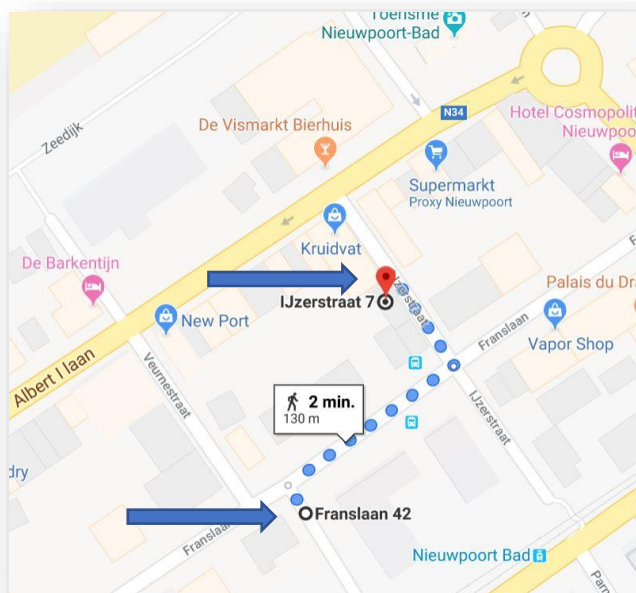

2 Please empty the dishwasher.

3 Remove the water from the coffee machine.

4 Please close all windows and leave the curtains down.

5 Please leave the used bed linen folded up on the kitchen table:

- Get the blanket out of the bedcloth.
- Get the pillowcase off the pillow.
- Remove the sheet from the mattress.

You do not need to remove the mattress protector and pillow protectors.

5 Please close the door and place the key back in the same key box with number 1 at the bottom of the building.

Some interesting locations:

Supermarkets (near)

Delhaize, Albert I laan 159, 8620 Nieuwpoort

Carrefour, Albert I laan 213, 8620 Nieuwpoort

Kruidvat, Albert I Laan 167-169, 8620 Nieuwpoort-Bad

Supermarkets

Colruyt, Jozef Cardijnlaan 33A, 8620 Nieuwpoort (= 2^{de} stop Coastal tram)

Aldi, Koning, Albert I laan 13, 8620 Nieuwpoort

Action, Albert I laan 295, 8620 Nieuwpoort

Bakery

De Franse bakker, Albert I laan 161, 8620 Nieuwpoort

Sandwiches

Juliette, Albert I laan 78, 8620 Nieuwpoort

De Franse bakker, Albert I laan 161, 8620 Nieuwpoort

Restaurant

Brasserie Casino, Zeedijk 29, 8620 Nieuwpoort (Franse keuken)

Tabl'o, Sint-Bernardusplein 4, 8620 Nieuwpoort (Tapas)

Barbouni, Kaai 39, 8620 Nieuwpoort (Grieks)

La Piazza, Albert I laan 293, 8620 Nieuwpoort (Italiaans)

Brasserie Het Kompas, Henegouwenstraat 1, 8620 Nieuwpoort (Franse keuken)

La Scala, Lombardsijdestraat 7, 8620 Nieuwpoort (Italiaans)

Pub

De Vismarkt, Albert I laan 120, 8620 Nieuwpoort

TerrasKaffee, Albert I laan 268, 8620 Nieuwpoort

Beach-bar

Barza Beach, Leopoldplein, 8620 Nieuwpoort (dijk)

General info

Charging cables for smartphone and equipment are provided in the kitchen cabinet:



Heating

The apartment is heated with electric radiators.

The heating is at a constant pleasant temperature, normally you do not need to change anything.

To change the temperature with the room thermostat:



1. Turn on the thermostat with the white push button.



2. Turn the white dial and select the 'sun' with the arrow on the right.



3. Press the white keys (+ or -) to set the desired temperature.

4. Then leave the display like this and place the thermostat back under the TV on the TV furniture.

Please never turn off the room thermostat or display completely.

The thermostat must be constantly communicating with the radiators.

Please always place the room thermostat under the TV on the TV furniture for optimal reception. Please do not place the thermostat on the coffee tables to prevent falling off.

(The room thermostat is fragile and won't work anymore when it falls).

SAFETY:

Please never cover the radiators with towels or clothing.

Entrance door apartment:

The door will open 90 degrees (not 180 degrees). The door is currently taped to prevent damage to the inner door. Please do not remove this tape (This will be solved).

You can always close the door from the inside.

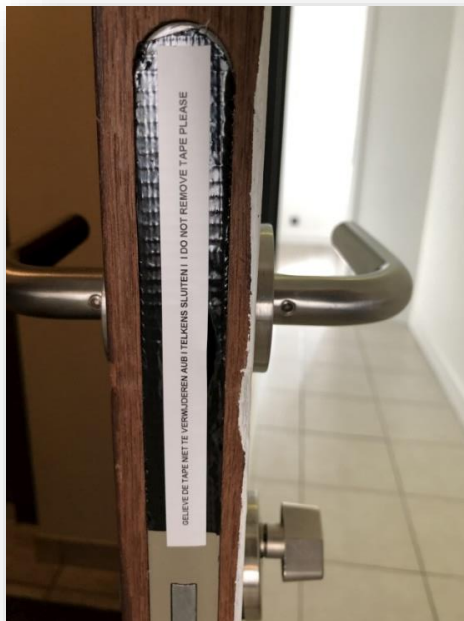

Cleaning cloths:

Cleaning cloths are available in the apartment and can be used if necessary.

Dirty cloths can be left in the bucket.

Safety:

In the common hall you can find the elevator.

Please do not use the elevator in case of emergencies. Please use the stairs.

In the common hall you can find a door on the left side of the staircase door with a fire extinguisher.

In the apartment there is a smoke detector/CO-detector present above the door of the livingroom in the hall.

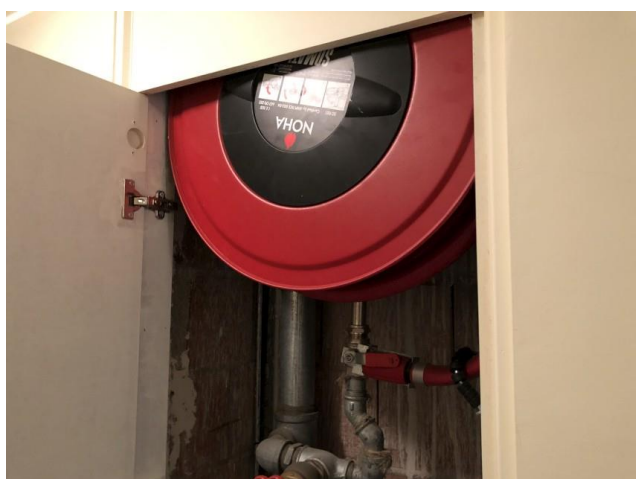
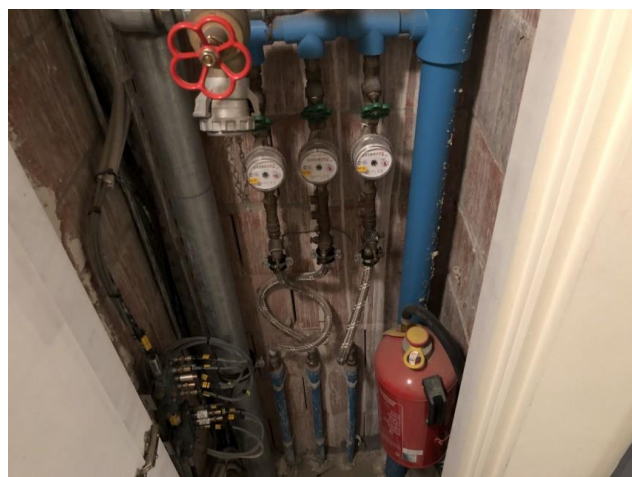

BRANDINSTRUCTIES – CONSIGNES EN CAS D'INCENDIE

INSTRUCTIONS IN CASE OF FIRE – VERHALTEN IM BRANDFALL

1.



Blijf rustig en bel:
Restez calme et appelez le:
Stay calm and dial:
Ruhe bewahren und Brand melden:

No./Nr. 112

2.



Geef duidelijke informatie over:
plaats en omvang van de brand + aantal slachtoffers
Faites clairement mention:
de l'endroit et l'importance de l'incendie + nombre de victimes
Give clear information about:
the place and the extent of the fire + number of victims
Genauere Informationen über Feuer (Was), Ort (Wo) und Opfer (Wie viele) geben.

3.



Blus de brandhaard
Eteignez le foyer d'incendie
Extinguish the fire
Löschversuch unternehmen

4.



Sluit ramen en deuren en verlaat de gevarezone
Fermez les portes et les fenêtres et quittez la zone de danger
Close windows and doors and leave the danger zone
Fenster und Türen schließen und die Gefahrenzone verlassen



Bij versperring van de normale vluchtweg, gebruik de tweede evacuatiweg
Maak uw aanwezigheid duidelijk
Si la sortie normale n'est plus accessible, utilisez la 2ème sortie d'évacuation
Signalez votre présence de façon claire
If the regular exit cannot be used, use the 2nd evacuation possibility
Make your presence clear
Bei Versperrung des normalen Fluchtwegs, den zweiten Fluchtweg benützen
Machen Sie sich bemerkbar

5.



Bij brand de lift niet gebruiken
En cas d'incendie ne pas utiliser l'ascenseur
Do not use the elevator in case of fire
Aufzug im Brandfall nicht benutzen

6

Blijf ter beschikking van de brandweer om
verdere informatie te verschaffen
Restez à la disposition des pompiers pour
fournir de plus amples informations

Stay available for the firemen to give them further information
Stellen Sie sich der Feuerwehr zur Verfügung, um weitere
Informationen zu erteilen.

House Rules

1. Have a nice stay in the apartment and in 'Nieuwpoort' !
2. Please do not place any shoes or other items in the common entrance hall or in front of the door. (The neighbours have already made remarks on this.)
 - Your shoes can be stored under the bed in the bedroom in the plastic boxes.



3. Think of the neighbours: please respect silence between 22:00 pm and 8:00 am.
4. Please take care of the apartment and the equipment.
5. Please do not make any changes to the WiFi network. The heating and hot water are WiFi controlled. Making changes means no heating and cold water, they cannot be restored until after the stay.
6. No smoking in the apartment.
7. The use of gourmet, fondue or barbecue equipment is not allowed.
8. Pets are not allowed.